

小光阳四冲

车型代号: 322



PARTS CATALOGUE

CONTENT

1. SPEEDOMETER	———01	12. VEHICLE FRAME	———13
2. FRONT COVER	———02	13. ELECTRIC ASSY	———15
3. TAILLIGHT	———03	14. FRONT ABSORBER	———17
4. SEAT LOCK	———04	15. REAR WHEEL ASSY	———18
5. PROTECTING	———05	16. CABLE	———20
6. FOOT BOARD	———07	17. FRONT WHEEL ASSY	———21
7. AIR FILTER ASSY	———08	18. ENGINE ASSY	———23
8. MUFFLER	———09	19. CARBURETOR ASSY	———24
9. HANDLERBAR	———10	20. TOOL KIT	———25
10. SEAT ASSY	———11		
11. FUEL BOX	———12		

一、仪表、仪表罩

NO:01

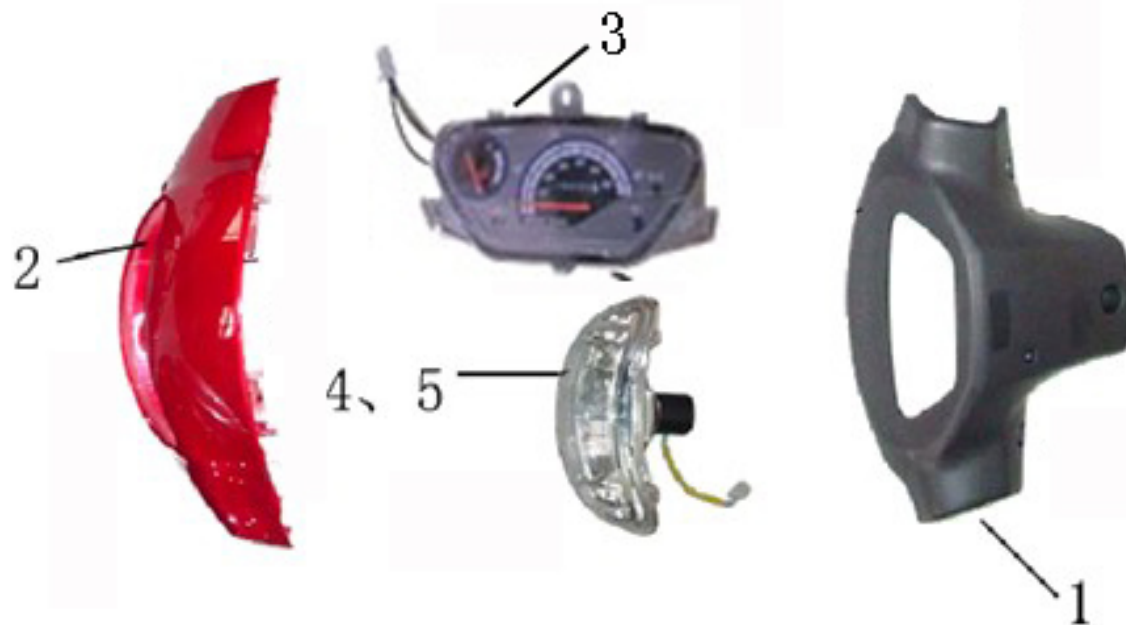

NO.	Part NO.	Description	Description in English	数量 Qty	备注 Remark
1.	1109000000-322	仪表壳	COVER SPEEDOMETER; UPPER	1	
2.	1158000000-322	挡风罩	COVER, HEAD LIGHT	1	
3.	1300000000-322	仪表	METERS	1	
4.	1258000000-322	前大灯	HEADLIGHT	1	
5.	1258000001-322	前大灯灯泡	BULB OF HEADLIGHT	1	

二、前面板

NO: 02



NO.	Part NO.	Description	Description in English	数量 Qty	备注 Remark
1.	1102000000-322	前罩	FRONT COVER	1	
2.	1110000000-322	前护条	LITTLE COVER OF FRONT COVER	1	
3.	1205000000-322	前装饰灯	PARKING LIGHTS	1	
4.	1204000000-322	前右转向灯	RIGHT TURNING LIGHT	1	
5.	1203000000-322	前左转向灯	LEFT TURNING LIGHT	1	
6.	1814000000-322	喇叭支架	PLATE OF HORN	1	
7.	1205000001-322	前位置灯灯泡	BULB OF PARKING LIGHTS	1	

三、尾灯组件组件

NO: 03

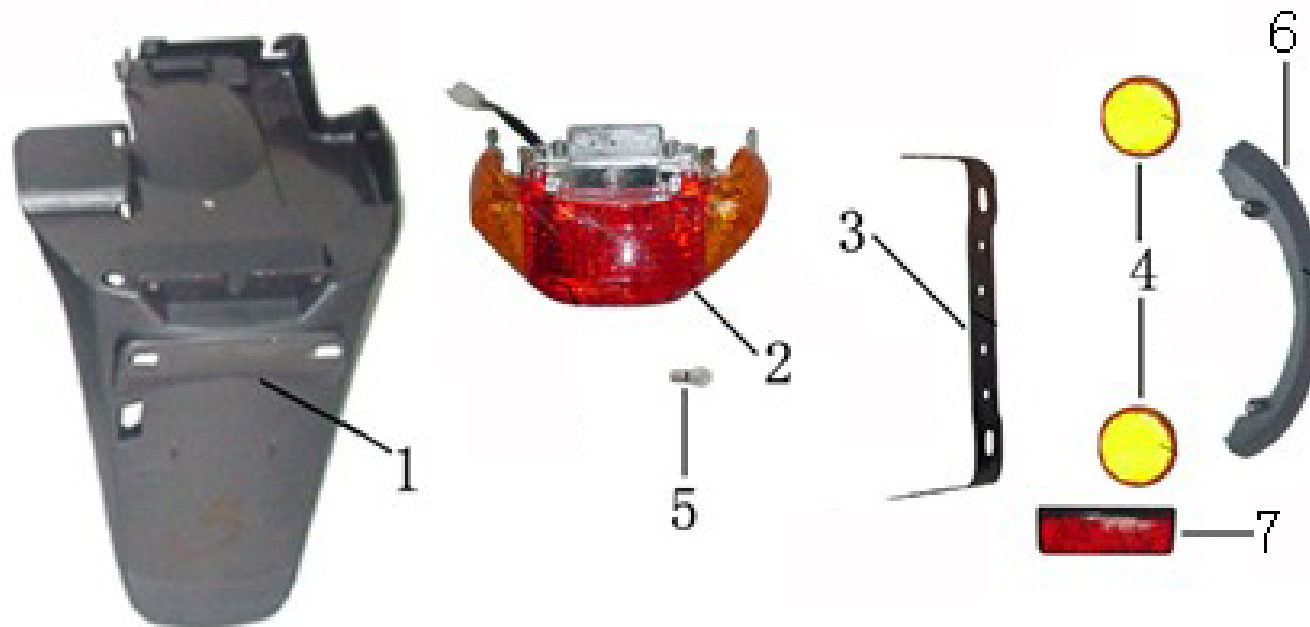

NO.	Part NO.	Description	Description in English	数量 Qty	备注 Remark
1.	11110600-322	后挡泥板	REAR FENDER	1	
2.	12020000-322	后尾灯总成	REAR LAMP ASSY	1	
3.	18050000-322	牌照支架	STAY, REAR REGISTRATION PLATE	1	
4.	12060000-322	侧反射器	SIDE REFLECT	2	
5.	12020001-322	后尾灯灯泡	BULB OF TAILLIGHT	1	
6.	11110400-322	后护条	BACK PROTECTIVE COVER	1	
7.	12070000-322	后反射器	RR. REFLECTOR	1	

五、左、右装饰板

NO: 05

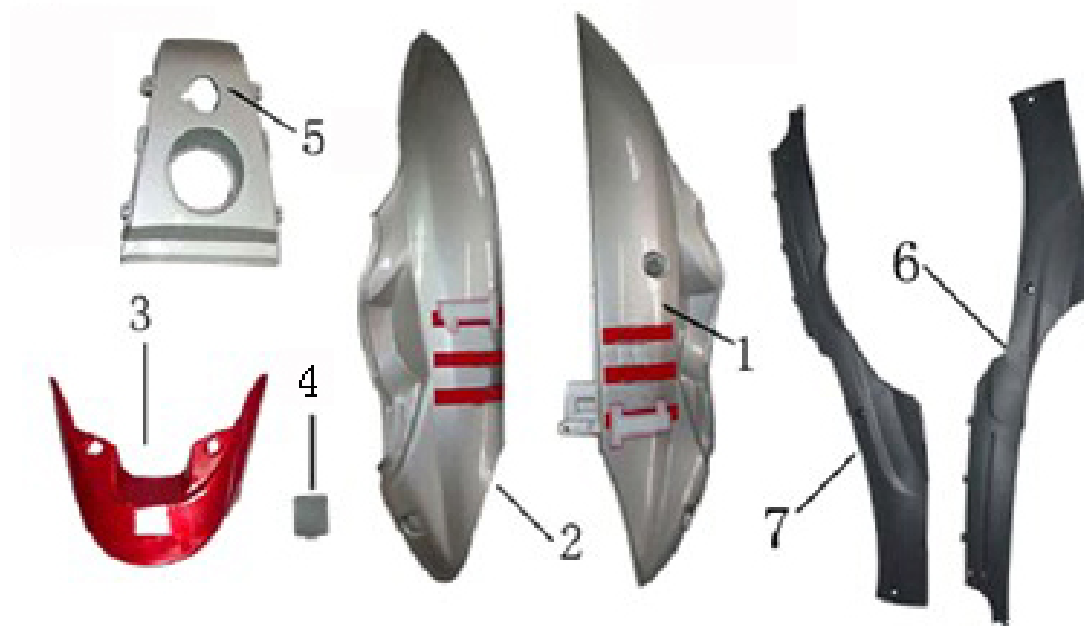

NO.	Part NO.	Description	Description in English	数量 Qty	备注 Remark
1.	11040000-322	左装饰板	SIDE COVER;LEFT	1	
2.	11050000-322	右装饰板	SIDE COVER;RIGHT	1	
3.	11080000-322	后货架盖板	HAND HOLD COVER	1	
4.	11110700-322	后货架盖板（小盖）	S. HAND HOLD COVER	1	
5.	11060000-322	后装饰板	REAR CENTER COVER	1	
6.	11110200-322	左护条	L. SIDE BAR	1	
7.	11110300-322	右护条	R. SIDE BAR	1	

六、脚踏板组件

NO: 06

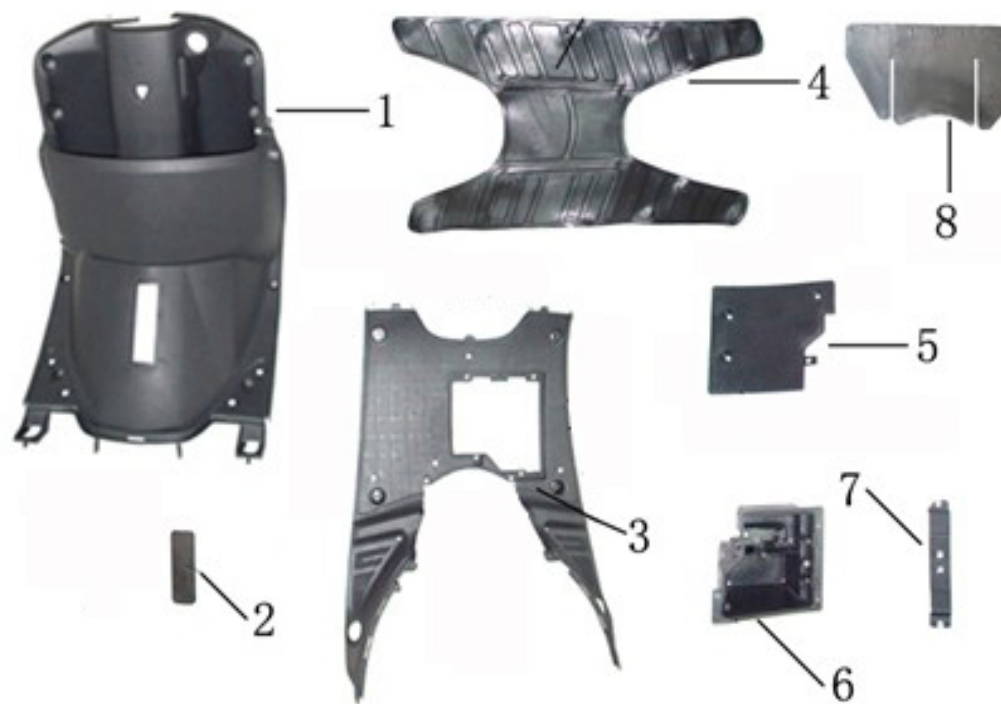

NO.	Part NO.	Description	Description in English	数量 Qty	备注 Remark
1.	11158000-322	工具箱	TOOL BOX	1	
2.	11110800-322	车架号码盖	VIN NUMBER COVER	1	
3.	11102000-322	脚踏板	FOOT BOARD	1	
4.	11111000-322	脚踏皮	FOOT SKIN	1	
5.	11104000-322	电瓶盖	COVER OF BATTERY	1	
6.	11103000-322	电瓶盒	BATTERY BOX	1	
7.	11110000-322	电瓶压条	BATTERY FIXING PLATE	1	
8.	11111580-322	挡水皮	R. SKIN	1	

八、排气消声器

NO: 08



NO.	Part NO.	Description	Description in English	数量 Qty	备注 Remark	
1.	04580000-322	消声器	MUFFLER	1		
2.						
3.						
4.						
5.						
6.						

九、方向把总成

NO: 09



NO.	Part NO.	Description	Description in English	数量 Qty	备注 Remark
1.	08100001-322	左握把	LEFT HANDLEBAR	1	
2.	08103000-322	方向把	HANDLE BAR	1	
3.	08101000-322	右握把	RIGHT HANDLEBAR	1	
4.	08301000-322	左后视镜	MIRROR LEFT	1	
5.	08302000-322	右后视镜	MIRROR RIGHT	1	
6.	15101000-322	左把手开关	SWITCH OF LEFT HANDLEBAR	1	
7.	15102000-322	右把手开关	SWITCH OF RIGHT HANDLEBAR	1	
	08100001-322	锁紧块	FIXATION PLATE	1	

十、座垫总成

NO: 10



NO.	Part NO.	Description	Description in English	数量 Qty	备注 Remark
1.	11108000-322	杂物箱前罩	FRONT COVER OF LUGGAGE	1	
2.	10000000-322	座垫	SAET ASSY	1	
3.	11107000-322	杂物箱内盖	INNER COVER OF LUGGAGE	1	
4.	11106000-322	杂物箱	LUGGAGE BOX	1	

十一、油箱总成

NO: 11



NO.	Part NO.	Description	Description in English	数量 Qty	备注 Remark
1.	11100000-322	油箱	FUEL BOX	1	
2.	11600000-322	燃油过滤器	FUEL FILTER	1	
3.	11400000-322	燃油传感器	FUEL SENSOR UNIT	1	
4.	11300000-322	油箱开关	SWITCH PETCOCK	1	
5.					
6.					
7.					
8.					
9.					



NO.	Part NO.	Description	Description in English	数量 Qty	备注 Remark
1.	06580000-322	车架	VEHICLE FRAME	1	
2.	06580001-322	左右车体支架	BODY BRACKET	2	
3.	06030000-322	单撑	SIDE STAND	1	
4.	11105000-322	车架挡泥板	FENDER, VEHICLE FRAME	1	
5.	06040000-322	双撑	CENTER STAND	1	
6.	06020000-322	动力吊架	HANGER	1	
7.	17580000-322	侧支撑拉簧	SPRING OF SIDE STAND	2	
8.	16060000-322	摇架缓冲橡皮	BUFFER OF HANGER	1	
9.	18040000-322	停车主支架轴 (带销孔)	SHAFT, CENTER STAND	1	
10.	17580000-322	停车主支架弹簧	SPRING, MAIN STAND	2	

十二、车架总成

NO:13



NO.	Part NO.	Description	Description in English	数量 Qty	备注 Remark
11.	07580001-322	侧支架熄火开关	STOPPING SWITCH, SIDE STAND	1	
12.	18030000-322	发动机安装衬套	ENGINE BUSHING	1	
13.	14020000-322	后货架	R. GOODS FRAME	1	
14.	18150000-322	侧支撑固定螺栓	BOLT OF SIDE STANE	1	

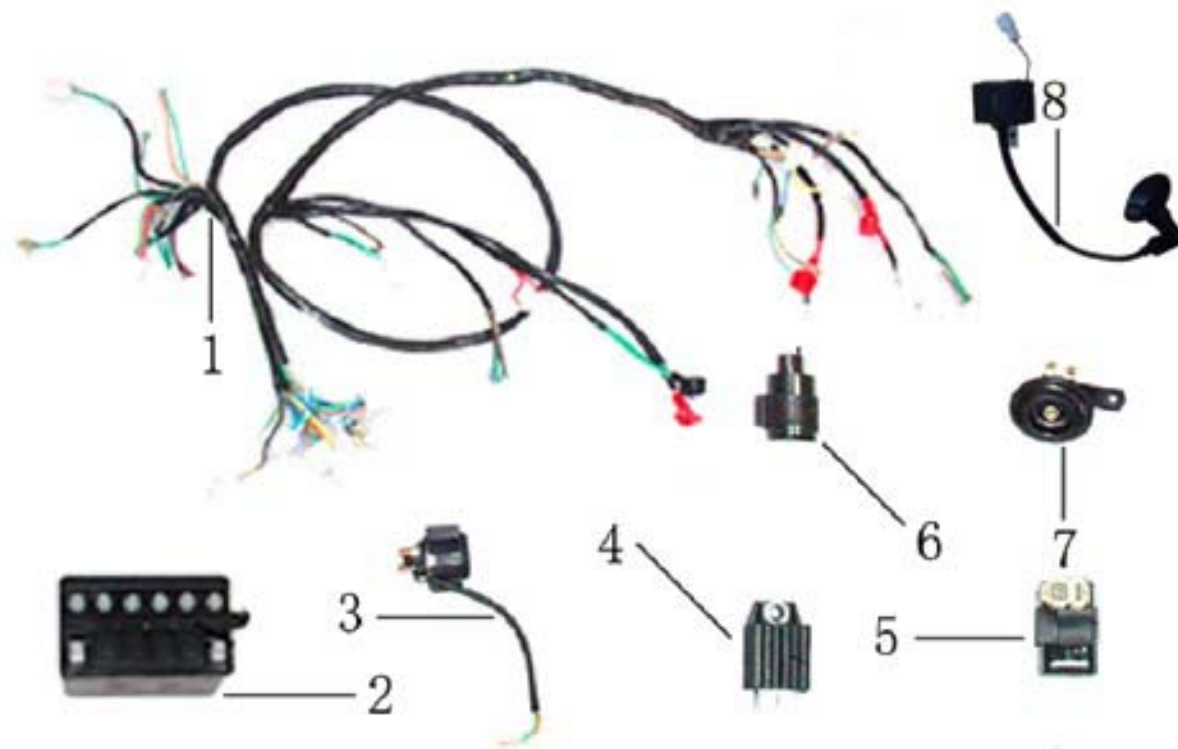

NO.	Part NO.	Description	Description in English	数量 Qty	备注 Remark
1.	07020000-322	主电缆	CABLE	1	
2.	07580000-322	蓄电池	BATTERY BOX	1	
3.	07090000-322	继电器	CAP RELAY ASSY	1	
4.	07060000-322	整流器	RECTIFIER ASSY	1	
5.	07070000-322	点火器	CDI ASSY	1	
6.	12080000-322	闪光器	FLASHER	1	
7.	12090000-322	喇叭	HORN	1	
8.	07080000-322	高压包	HIGH VOLTAGE WIRE ASSY	1	



NO.	Part NO.	Description	Description in English	数量 Qty	备注 Remark
1.	05120000-322	后轮胎	TYRE	1	
2.	05080000-322	后铝轮	REAR WHEEL	1	
3.	11110600-322	后轮泥板	FENDER OF REAR WHEEL	1	
4.	08580000-322	后减震器	REAR ABSORBER ASSY	1	
5.	18100000-322	后轮挡泥板支架	BRACKET PLATE	1	
6.	05090000-322	后刹车凸轮轴	REAR BRAKE AXLE	1	
7.	05110000-322	后制动蹄块	BRAKE SHOE	2	
8.	05100000-322	后刹车摇臂	BRAKE ROCKET	1	

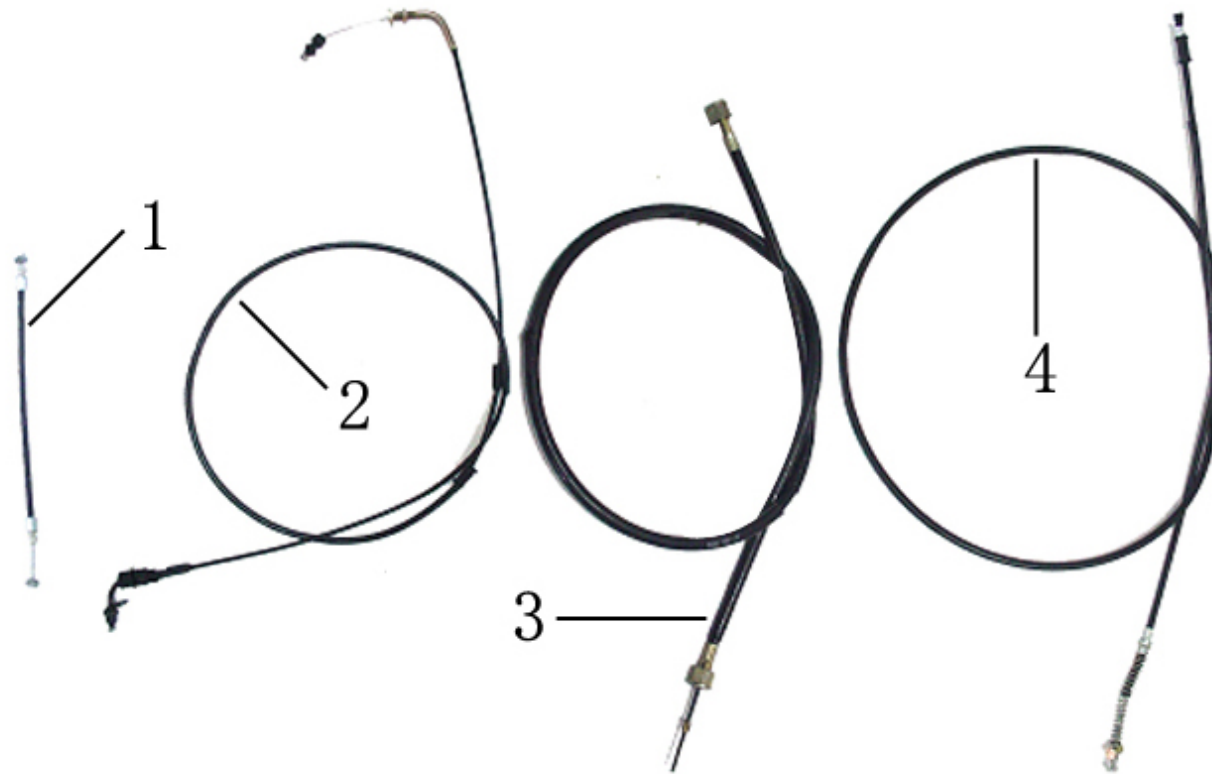

NO.	Part NO.	Description	Description in English	数量 Qty	备注 Remark
1.	09040000-322	座垫锁拉线	SEAT LOCK CABLE	1	
2.	09580000-322	油门线	THROTTLE CABLE	1	
3.	09020000-322	里程表线	SPEEDOMETER CABLE	1	
4.	09030000-322	后刹车线	REAR BRAKE CABLE	1	

十七、前轮总成

NO: 21



NO.	Part NO.	Description	Description in English	数量 Qty	备注 Remark
1.	05040000-322	前轮胎	TYRE	1	
2.	05580000-322	前铝轮	FRONT WHEEL	1	
3.	05020000-322	前轮轴	AXLE OF FRONT WHEEL	1	
4.	05030000-322	前轮轴套	BUSHING OF FRONT WHEEL	1	
5.	07200100-322	前制动蹄块	F. BRAKE SHOE	1	
6.	07500000-322	前制动毂盖	F. BRAKE COVER	1	
7.	11030000-322	前轮挡泥板	FRONT FENDER	1	
8.	18080000-322	前挡泥板支架	BRACKET OF FRONT FENDER	1	
9.	05070000-322	计数器	COUNTER	1	
10.	11070000-322	前泥后部	TAIL, FRONT FENDER	1	

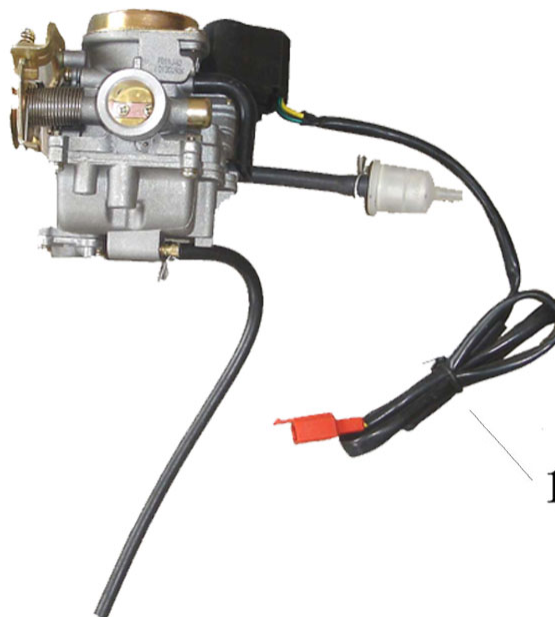

1

NO.	Part NO.	Description	Description in English	数量 Qty	备注 Remark	
1.	01200000-322	化油器总成	CARBURETOR ASSY	1		
2.						
3.						
4.						
5.						
6.						
7.						
8.						

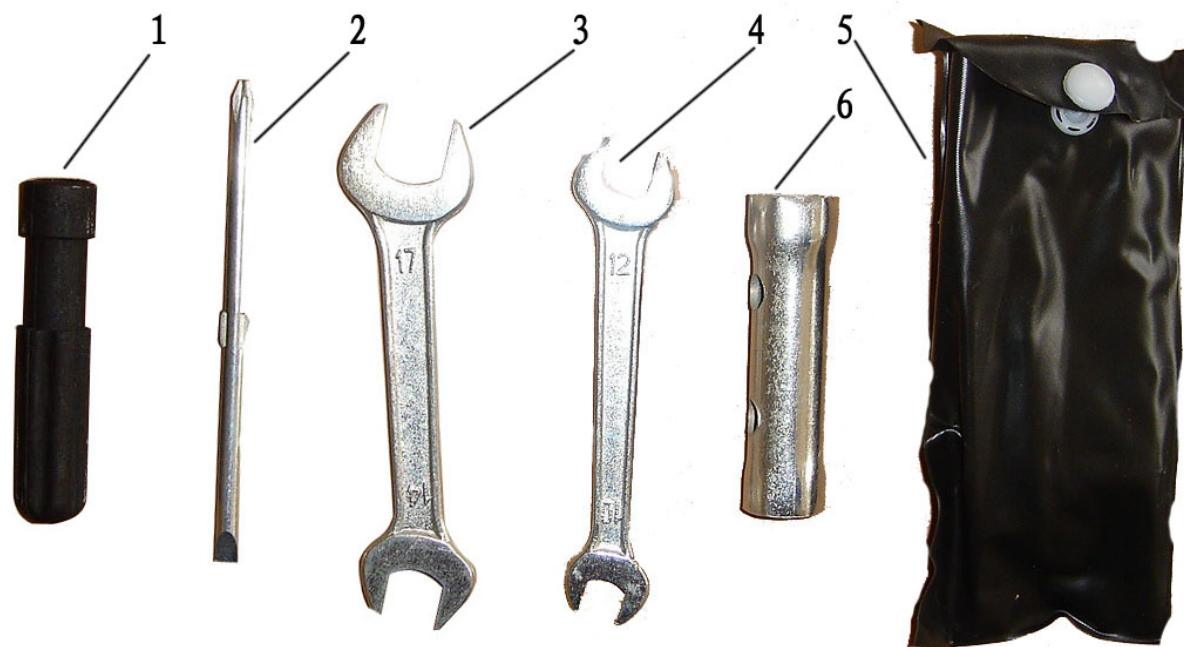

NO.	Part NO.	Description	Description in English	数量 Qty	备注 Remark
1.	05000006-322	起子手柄	HANDLE, SCREW DRIVER	1	
2.	05000004-322	两用旋具	DRIVER	1	
3.	05000003-322	呆扳手 14X17	WRENCH	1	
4.	00500002-322	呆扳手 10X12	WRENCH	1	
5.	00505800-322	随车工具包	BAG	1	
6.	05000005-322	火花塞套筒	SOCKET	1	
7.		标准件	STANDARD PARTS	1	

新世纪远豪

ENGINE TYPE: 50# 加长箱体

Content

1. CRANKCASE	-----	01
2. CRANK SHAFT & CYLINDER	-----	02
3. OIL PUMP & START MOTOR	-----	03
4. RIGHT CRANKCASE COVER & GENERATOR	-----	04
5. CYLINDER HEAD & AIR VALVE ASSY	-----	05
6. CYLINDER HEAD CAP & FAN COVER	-----	06
7. LEFT COVER & START WHEEL ASSY	-----	07
8. TRANSMISSION ASSY	-----	08
9. REAR TRANSMISSION ASSY	-----	09

